

# INWALL 1

0049270 CFL 9W G23 - 2.1kg  
0049271 CFL 9W G23- 2.1kg

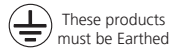

IK08

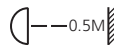

IP55



IS10041

**Disconnect from mains supply before replacing the fuse or the lamp.**  
Vor dem Einsetzen der Sicherung oder der Lampe Spannungsfreiheit herstellen.  
**Débrancher le secteur avant de remplacer le fusible ou l'ampoule.**  
Desconectar del suministro de la red, antes de realizar la sustitución del fusible o de la lámpara.  
**Voor het vervangen van lamp of zekering, eerst netspanning uitschakelen.**  
Kopla bort spänningen före byte av en säkring eller en lampa.

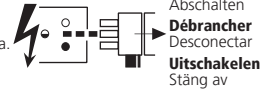

## 1 Body

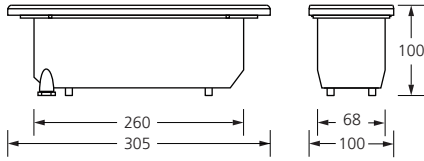

## Mounting box

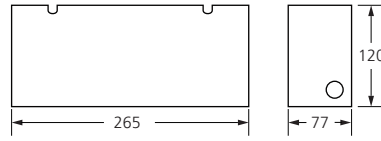

## 2

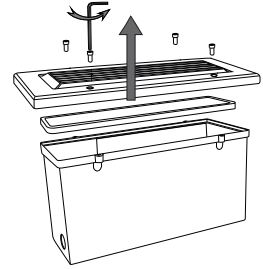

## 3

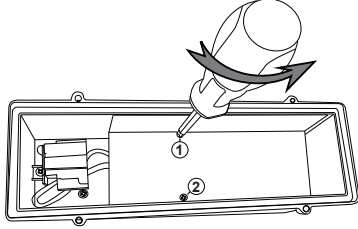

## 7

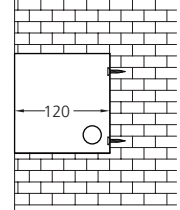
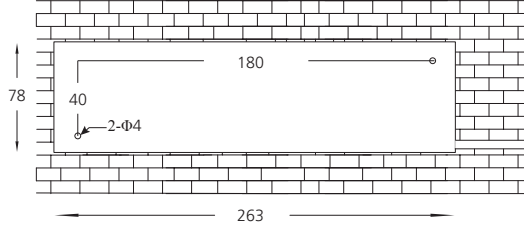

## 4

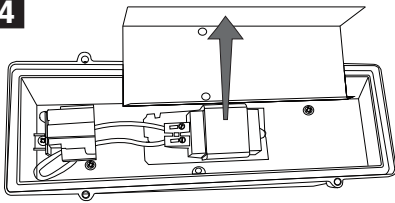

## 8

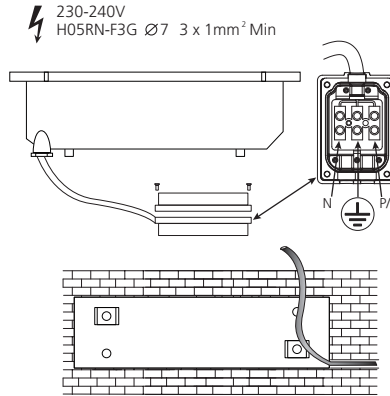

## 10

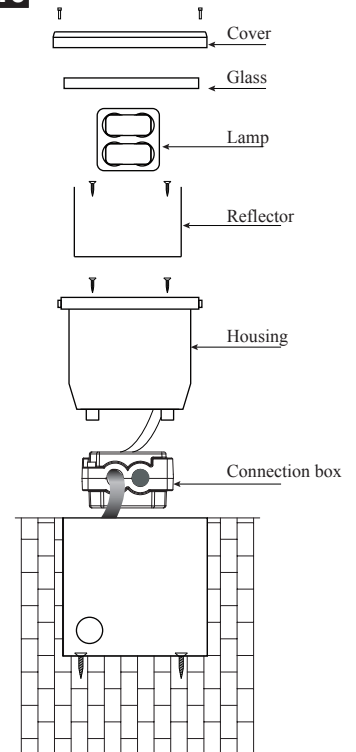

## 5

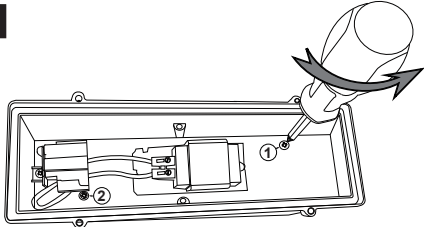

## 6

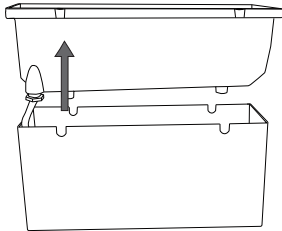

## 9

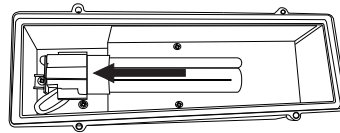

### Replace any cracked protective shield.

Dieses symbol bedeutet, dass defekte Schutzgläser sofort ersetzt werden müssen.  
**Ce symbole indique que vous devez remplacer tout verre de protection fêlé.**

Este símbolo indica que hay que reemplazar filtros en caso de rotura o desperfectos.

**Dette symbolet indikerer at alle ødelagte (sprukne) sikkerhetsglass må skiftes.**

Valaisinta el saa käyttää ilman suojalasia vioitunut suojalasi on vaihdettava uuteen ennen valaisimen käyttöön ottoa.

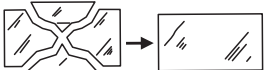

**SYLVANIA**  
www.havells-sylvania.com

Havells Sylvania Europe LTD  
Avis Way, Newhaven East Sussex  
BN9 0ED UK  
www.havells-sylvania.com

